

Dr-35

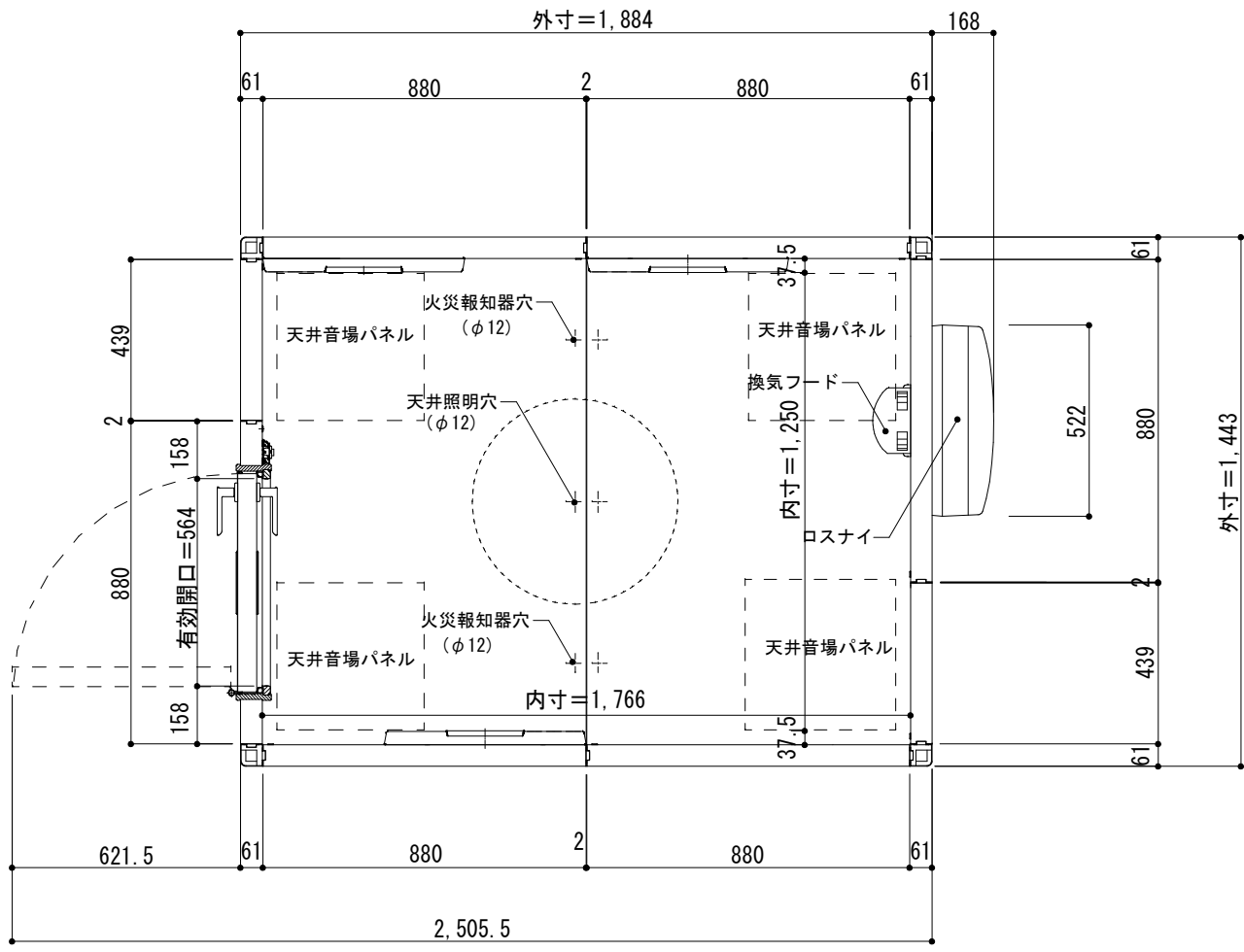

Dr-40

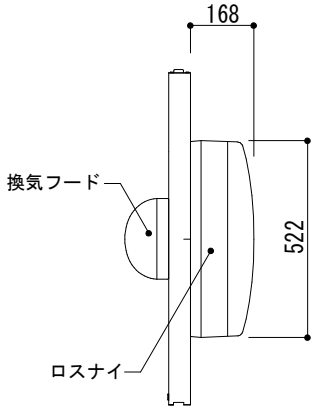

1.5畳 平面図 S=1/20