

Dr-35

Dr-40

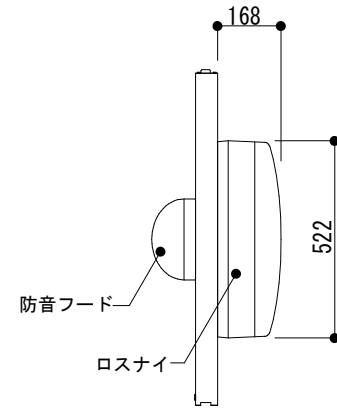
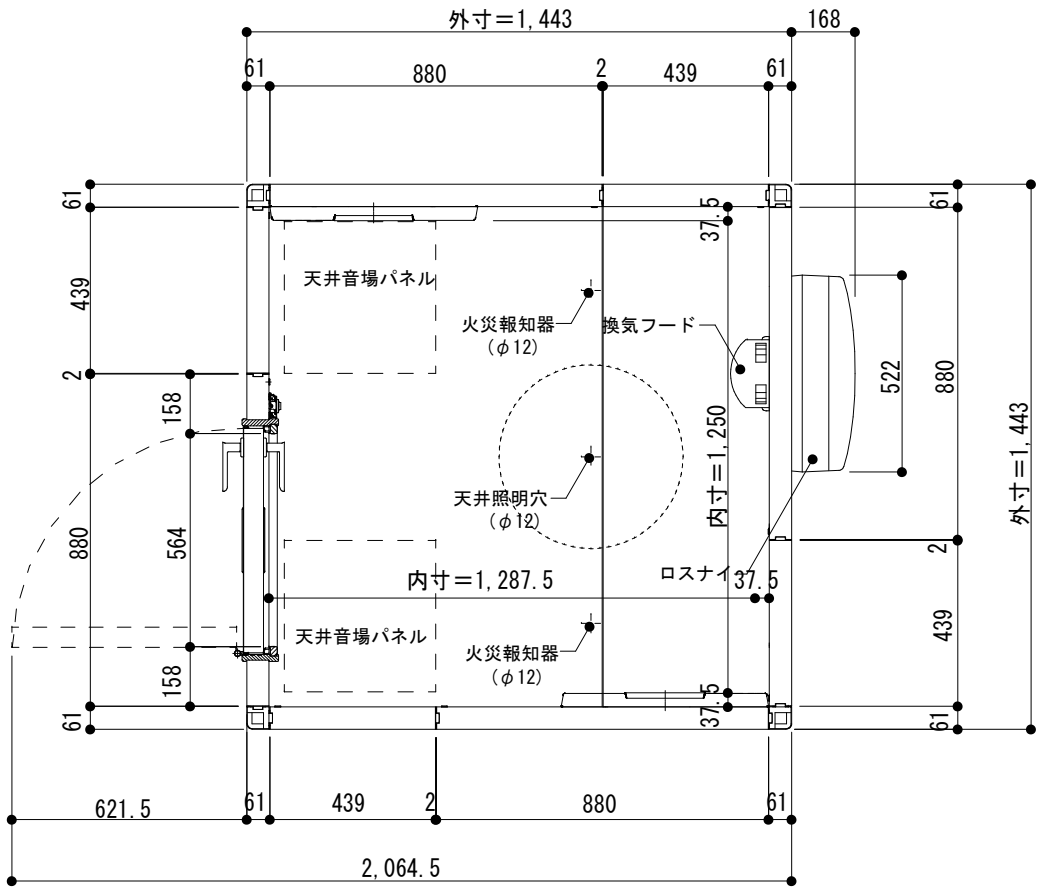

1.2 畳 平面図 S=1/20